



■ Vers. 009



■ Vers. 009







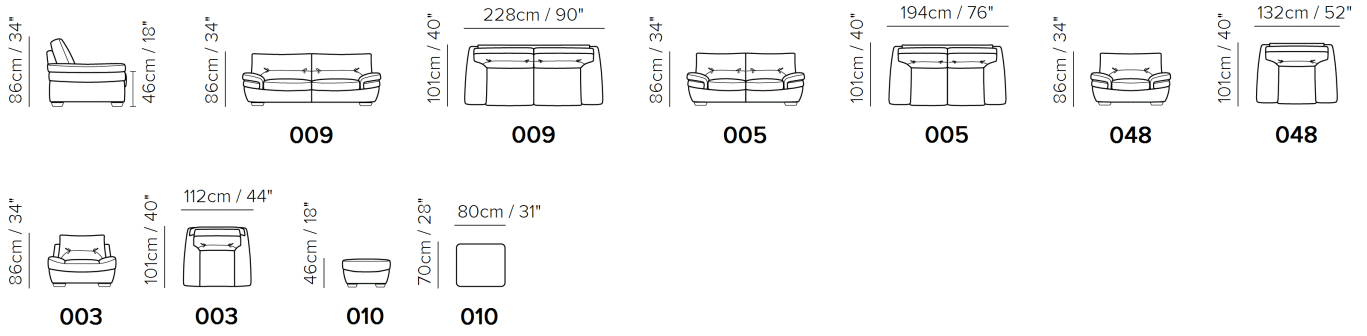

■ Vers. 048

SCHEMATICS



TECHNICAL INFORMATION

	COVERING	Leather <input checked="" type="checkbox"/>	Soft Cover <input checked="" type="checkbox"/>			
	LEGS	Metal <input type="checkbox"/>	Wood <input checked="" type="checkbox"/>	Upholstered <input type="checkbox"/>	Castors <input type="checkbox"/>	Plastic <input type="checkbox"/>
	FILLING	Arms <input type="checkbox"/> Fiber <input checked="" type="checkbox"/> Foam <input type="checkbox"/> Feather/Fiber Mix <input type="checkbox"/> Feather	Seat cushion <input type="checkbox"/> Fiber <input checked="" type="checkbox"/> Foam <input type="checkbox"/> Feather/Fiber Mix <input type="checkbox"/> Feather	Back cushion <input checked="" type="checkbox"/> Fiber <input type="checkbox"/> Foam <input type="checkbox"/> Feather/Fiber Mix <input type="checkbox"/> Feather		
	COMFORT	Firm Comfort <input type="checkbox"/>	Standard Comfort <input checked="" type="checkbox"/>			
	FUNCTION	Bed <input type="checkbox"/>	Electric motion <input type="checkbox"/>	Motion <input type="checkbox"/>	Recliner <input type="checkbox"/>	Sliding <input type="checkbox"/>
	OPTIONS	Nails <input type="checkbox"/>	Contrast Stitching <input checked="" type="checkbox"/>	Removable <input type="checkbox"/>		

NOTES

- Contrast stitching is available only with certain covers and option is managed directly in NARES.
- All arms, back and seat surfaces are covered in Top Grain.
- This model is available with split leather exterior covering (Side, Rear and Front Panels)
- Tight Seat Cushion (the seat cushions of the models are fixed to the frame)
- Back Cushion with elastic belt with buckle (the back cushion is attached to the frame through an elastic belt with buckle)
- Wood Frame
- Without Feet Assembled (the feet will be in a bag inside the package)
- Plastic Wrap (the model will be wrapped in a plastic bag)
- Feet available in wood finishings 09 (Walnut) / 18 (Wengè)
- Feet height 5, 0 cm
- Chair (vers. 003) has a different arm in respect to all other versions.

NOTES
