

# Dimensions

## #728

## #628 (skirted)

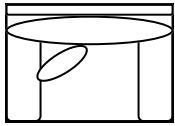

**-001 Lounge Chair**  
46x40x38

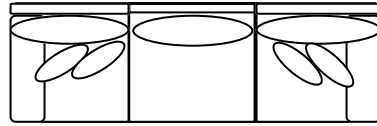

**-004 Estate Sofa**  
98x40x38

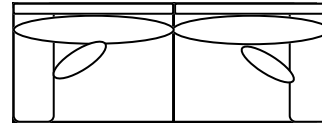

**-010 Loft Sofa**  
79x40x38

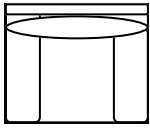

**-009 Ottoman**  
40x30x19

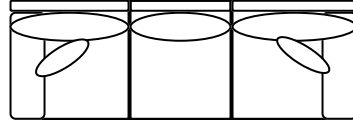

**-011 3 over 3 Sofa**  
86x40x38

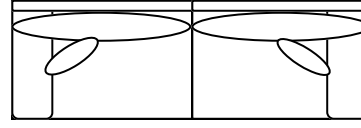

**-0112 2 over 2 Sofa**  
86x40x38

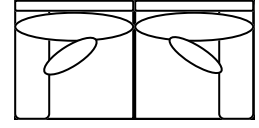

**-019 Loveseat**  
62x40x38

**-101 Chair**  
**-005 Swivel**  
40x40x38

**-109 Ottoman**  
30x24x19

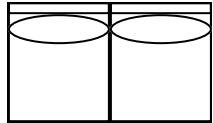

**-083 Armless Loveseat**  
46x40x38

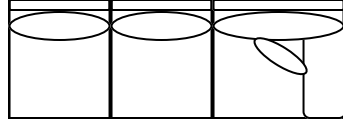

**-080 RSF One Arm Sofa**  
**-017 RSF One Arm Q Sleeper**  
77x40x38

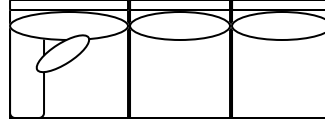

**-081 LSF One Arm Sofa**  
**-018 LSF One Arm Q Sleeper**  
77x40x38

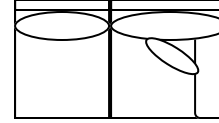

**-084 RSF 1-Arm Loveseat**  
55x40x38

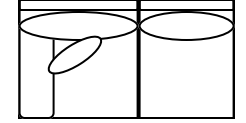

**-086 LSF 1-Arm Loveseat**  
55x40x38

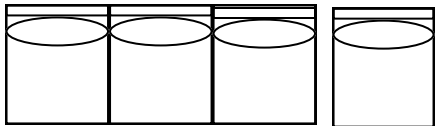

**-082 Armless Sofa**  
69x40x38

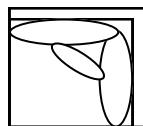

**-091 Armless Chair**  
23x40x38



**-090 Corner piece**  
40x40x38

**-095 Corner Wedge**  
66x40x38

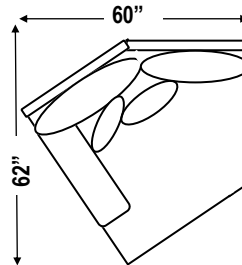

**-0C3 LSF 1-Arm Cuddle Section**  
**-0C4 RSF 1-Arm Cuddle Section**  
60x62x38

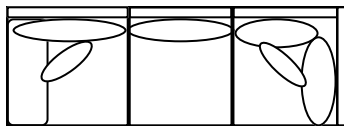
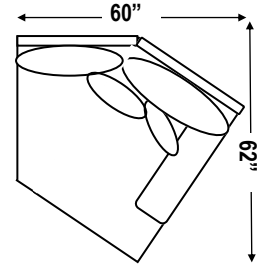

**-0A3 LSF One Arm Sofa Section**  
94x40x38

To be used with one-arm sofa, sleeper, loveseat, or chair only.

Will create a 94" L-shaped sectional.

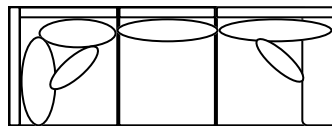

**-0A4 RSF One Arm Sofa Section**  
94x40x38

To be used with one-arm sofa, sleeper, loveseat, or chair only.

Will create a 94" L-shaped sectional.

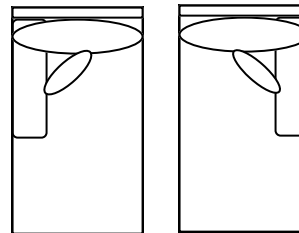

**-087 LSF One-Arm Chaise**  
**-085 RSF One-Arm Chaise**  
31x68x38

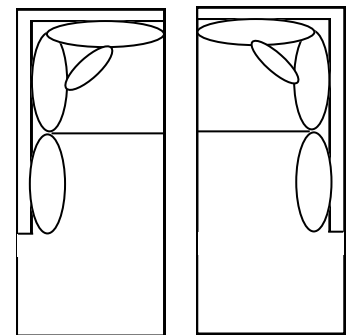

**-0B3 LSF 1-Arm Bumper Section**  
**-0B4 RSF 1-Arm Bumper Section**  
40x94x38

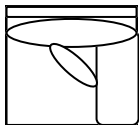

**-030 RSF 1-Arm Chair**  
**-031 LSF 1-Arm Chair**  
31x40x38

Sleeper mattresses are 72" in length.  
Total depth of sleeper with extended mattress is 93".  
(See diagram on right.)

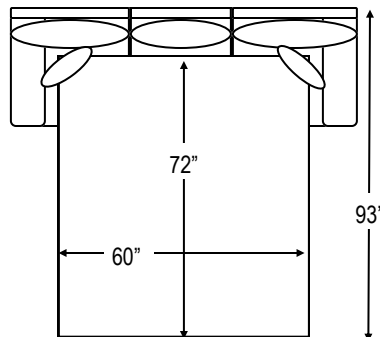

**-015 Queen Sleeper**  
**-0152 2over2 Queen Sleeper**  
86x40x38

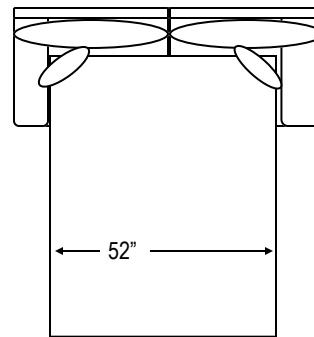

**-016 Loft Sofa w/ Full Sleeper**  
79x40x38

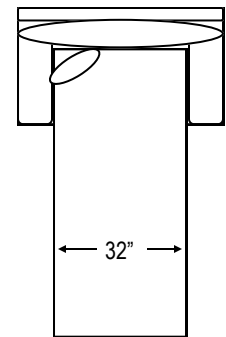

**-014 Twin Sleeper**  
57x40x38

