



5010-SECT in body fabric: 996-20
 5010-10 in body fabric: 650-72
 pillow fabric: 074-40

Finley

FLEXSTEEL®

Tailored Elegance

Simplicity and refinement meet ultimate comfort with the Finley collection. With a distinctive profile featuring sloped, tapered track arms and attractive welt detailing, Finley's classic stationary look also offers the enhanced option of power incline for ease of relaxation. Our patented Blue Steel Spring™ at the heart of each seat ensures a firm, yet flexible, sit. Offering generous seating space, and sitting stately on sleek, square tapered legs, Finley is the perfect choice for elevating your home.

STATIONARY MEETS MOTION



Finley's new power incline functionality brings the comfort of reclining to this classic stationary style.

DESIGNED FROM THE INSIDE OUT



For over 100 years, the Blue Steel Spring™ has differentiated Flexsteel products. Its strength and resilience creates a “just right” balance of softness, support and quality. So whether you've got big people or little people, wild jumpers or careless ploppers—not to worry—the Blue Steel Spring has got your back.

WARRANTY INFORMATION



Lifetime Limited Warranty: Springs, wood frames, seat cushions, and reclining mechanisms

Five-Year Limited Warranty: Mechanical and electrical components

One-Year Limited Warranty: Upholstery materials
 Visit www.flexsteel.com for complete warranty details.

SCAN ME
 For a digital copy of this sheet.



Finley

5010 fabric

3010 leather*

*Leather motion sofa group (Q3010) only offered in stocked leathers 946-78 & 705-72. Pillows not standard.

SH = Seat Height | SW = Seat Width
SD = Seat Depth | AH = Arm Height
OD = Open Depth

STATIONARY GROUP COLLECTION

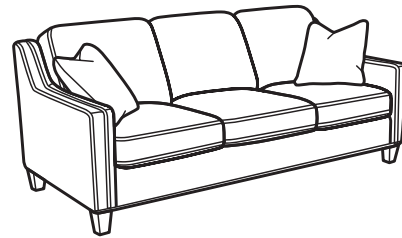

-31 SOFA

38H 88W 38D
21SH 77SW 23SD 26AH

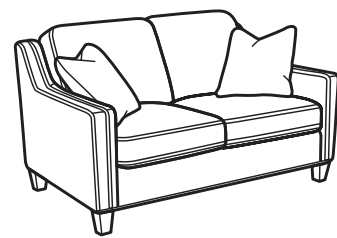

-20 LOVESEAT

38H 60W 38D
21SH 49SW 23SD 26AH

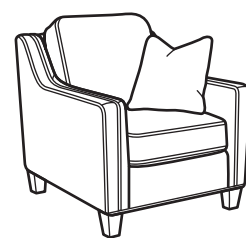

-10 CHAIR

38H 33W 38D
21SH 22SW 23SD 26AH

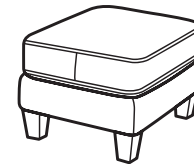

-08 OTTOMAN

19H 28W 23D

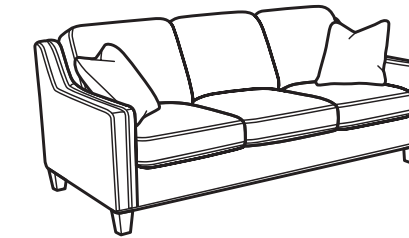

-620M POWER INCLINING SOFA

37H 87W 39D
21SH 76SW 21SD 25AH 57OD

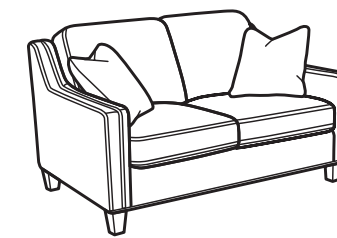

-600M POWER INCLINING LOVESEAT

37H 63W 39D
21SH 53SW 21SD 25AH 57OD

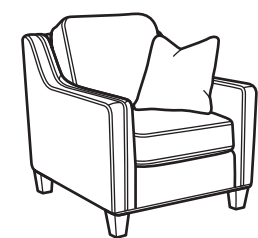

-500M POWER INCLINER

37H 37W 39D
21SH 26SW 21SD 25AH 57OD

SECTIONAL PIECES AND SAMPLE CONFIGURATIONS

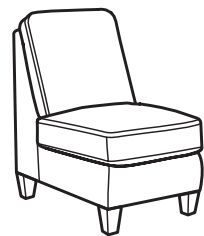

-19 ARMLESS CHAIR

39H 26W 38D
21SH 26SW 23SD

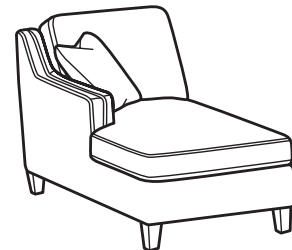

-25 LAF CHAISE

39H 31W 65D
21SH 30SW 54SD 26AH

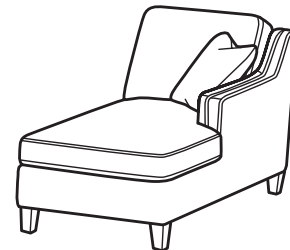

-26 RAF CHAISE

39H 31W 65D
21SH 30SW 54SD 26AH

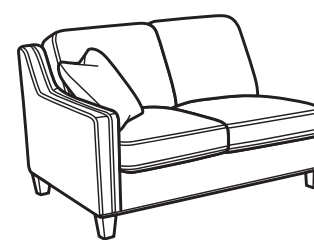

-27 LAF LOVESEAT

39H 56W 38D
21SH 52SW 23SD 26AH

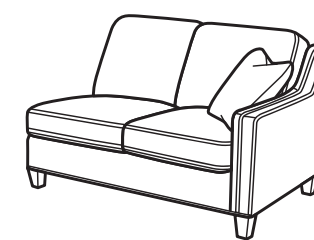

-28 RAF LOVESEAT

39H 56W 38D
21SH 52SW 23SD 26AH

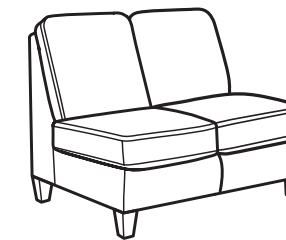

-29 ARMLESS LOVESEAT

39H 52W 38D
21SH 52SW 23SD

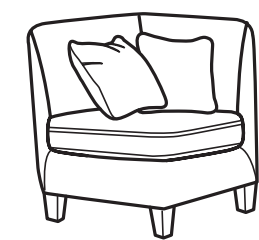

-231 CORNER CHAIR

39H 38W 38D
21SH 23SW 23SD

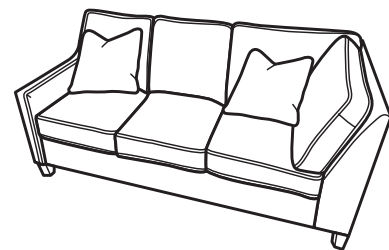

-33 LAF CORNER SOFA

39H 95W 38D
21SH 74SW 23SD 26AH

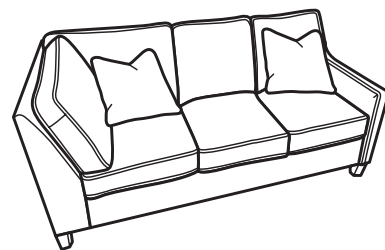

-34 RAF CORNER SOFA

39H 95W 38D
21SH 74SW 23SD 26AH

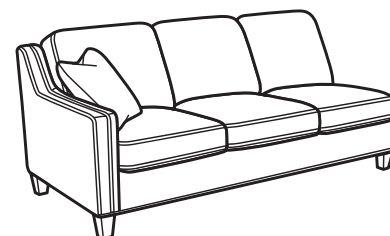
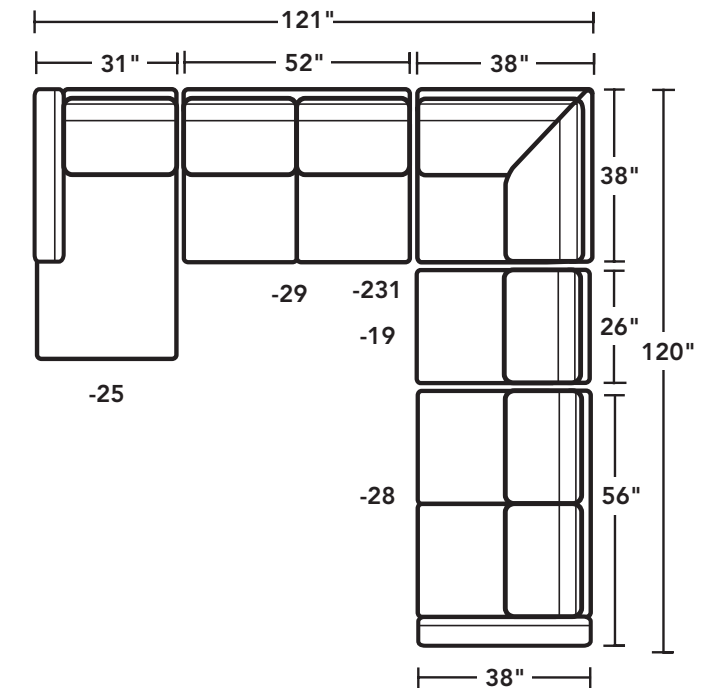
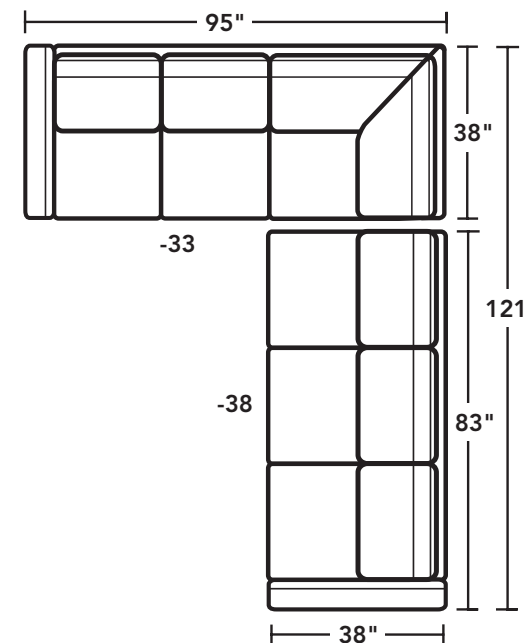
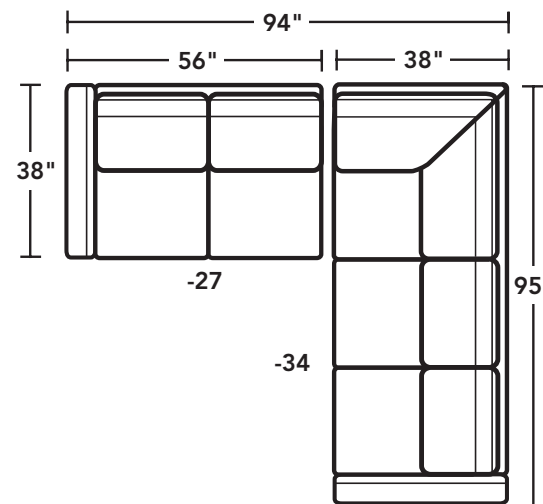

-37 LAF SOFA

39H 83W 38D
21SH 79SW 23SD 26AH

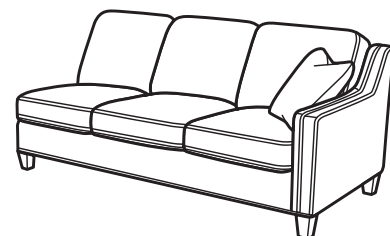

-38 RAF SOFA

39H 83W 38D
21SH 79SW 23SD 26AH