



■ Vers. 009



■ Vers. 154



■ Vers. 154



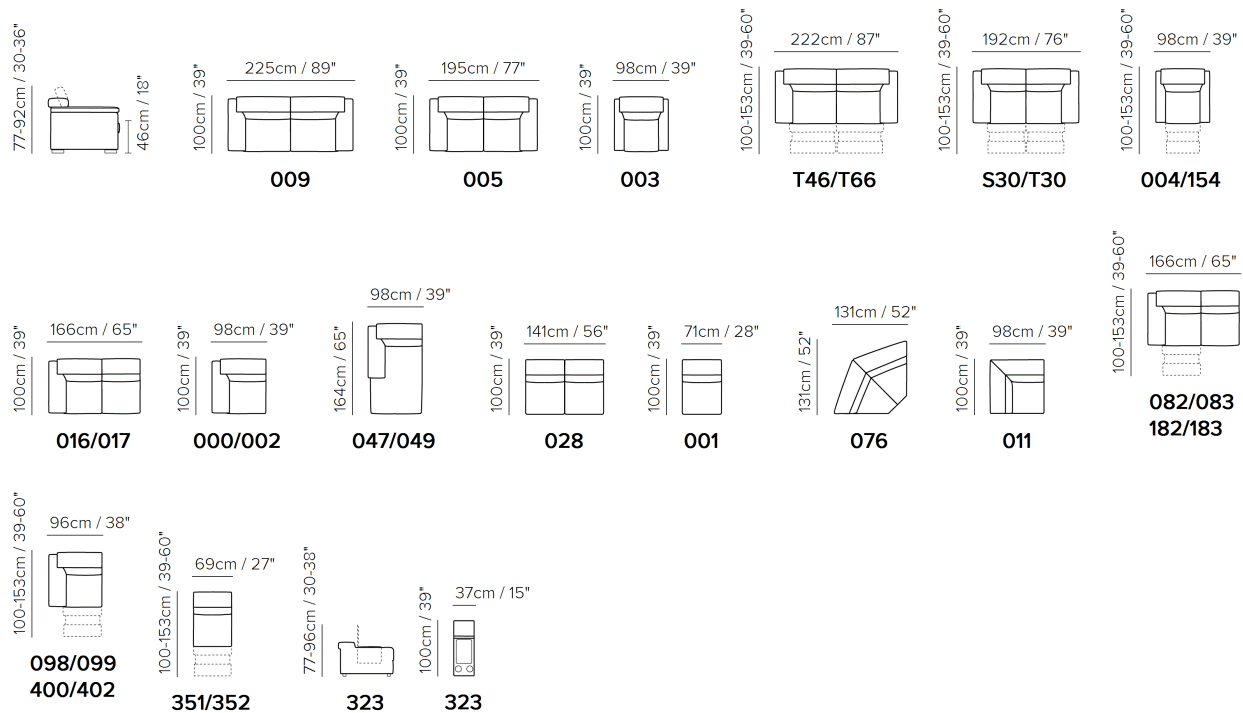

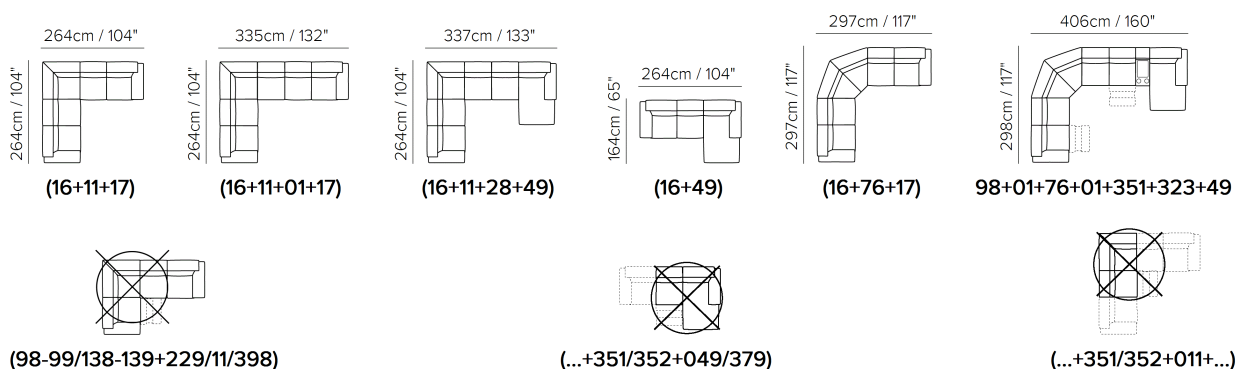

SCHEMATICS



COMPOSITION EXAMPLES



TECHNICAL INFORMATION

	COVERING	Leather <input checked="" type="checkbox"/>					
	LEGS	Wood <input checked="" type="checkbox"/>	Metal <input type="checkbox"/>	Plastic <input type="checkbox"/>	Castors <input type="checkbox"/>	Upholstered <input type="checkbox"/>	
	FILLING	Arms	<input type="checkbox"/> Fiber <input checked="" type="checkbox"/> Foam <input type="checkbox"/> Feather/Fiber Mix <input type="checkbox"/> Feather	Seat cushion	<input type="checkbox"/> Fiber <input checked="" type="checkbox"/> Foam <input type="checkbox"/> Feather/Fiber Mix <input type="checkbox"/> Feather	Back cushion	<input type="checkbox"/> Fiber <input checked="" type="checkbox"/> Foam <input type="checkbox"/> Feather/Fiber Mix <input type="checkbox"/> Feather
	COMFORT	Standard Comfort <input checked="" type="checkbox"/>		Firm Comfort <input type="checkbox"/>			
	FUNCTION	Bed <input type="checkbox"/>	Electric motion <input checked="" type="checkbox"/>	Motion <input checked="" type="checkbox"/>	Recliner <input checked="" type="checkbox"/>	Sliding <input type="checkbox"/>	
	OPTIONS	Nails <input type="checkbox"/>	Removable <input type="checkbox"/>	Contrast Stitching <input checked="" type="checkbox"/>			

NOTES

- Contrast stitching is available only with certain covers and option is managed directly in NARES.
- The model has external soft touch buttons on the arm to activate the mechanism.
- The model has manual adjustable headrest.
- All arms, back and seat surfaces are covered in Top Grain.
- This model is available with split leather exterior covering (Side, Rear and Front Panels)
- Tight Seat Cushion (the seat cushions of the models are fixed to the frame)
- Tight Back Cushion (the back cushions of the models are fixed to the frame)
- No Leather Side (the sectional pieces have the side covered with fabric and not leather)
- Wood Frame
- Without Feet Assembled (the feet will be in a bag inside the package)
- Plastic Wrap (the model will be wrapped in a plastic bag)
- Feet available in wood finishings 09 (Walnut) / 18 (Wengè)
- Feet height 5,0 cm

NOTES
