

## Standard / Ottomans / Armless

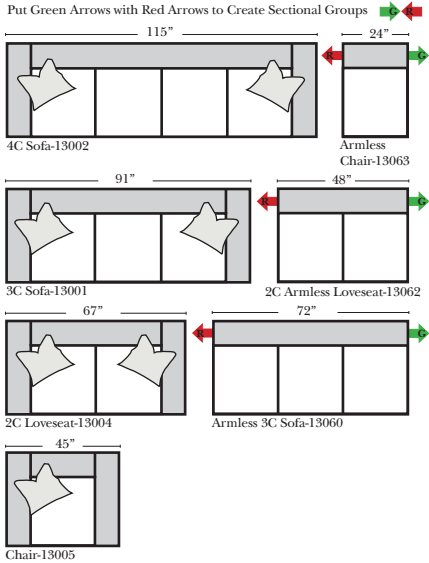

## 2-Piece Curve Sectional

2-Piece Curve Sectional not available for this style

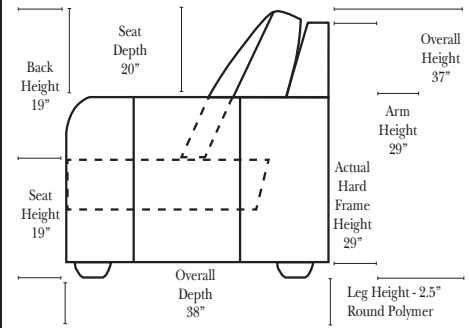
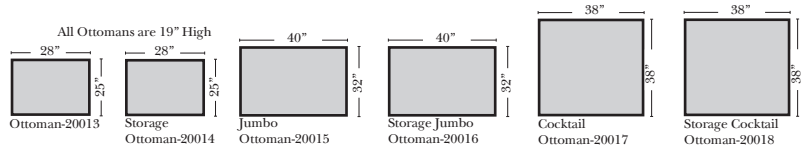

### Standard & options

#### Standard:

- Available in Full & Top Grain Leathers
- All Hardwood Frames
- Leg - Round Polymer

#### Options: (No Additional Charge)

- No. 33 Firm Foam Cushions

#### Options: (additional Charge)

- Down Seats & Down Backs

## L-Shape / 90 Degree Sectional

(All 4 seat items ship as one piece if stationary, two pieces if motion installed)

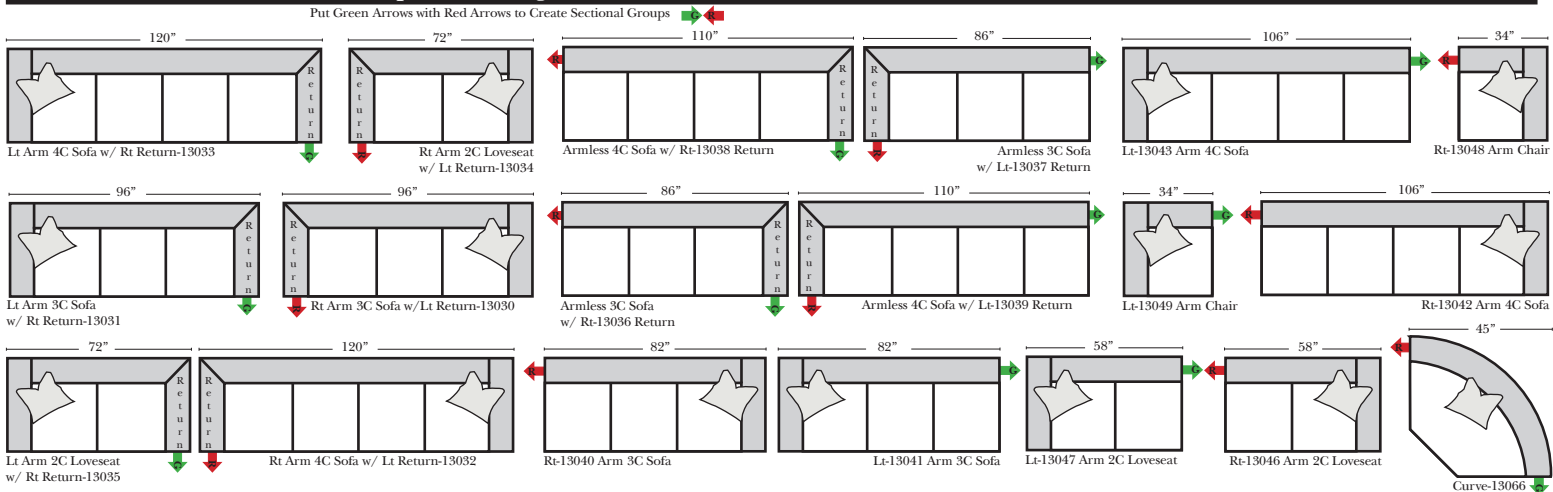

### Sleeper Options: (All the below options are at additional charges)



- Queen Sleeper available w/Standard Mattress
- Twin Sleeper available w/Standard Mattress
- Deluxe Innerspring Mattress: Queen / Twin
- Air Dream Coil Mattress: Queen Only - (No Twin)
- Hideaway Air Mattress: Queen Only (Shipped in a Separate Box)



#### Note:

All Dimensions are approximate, if accuracy is crucial, please contact us for validation of the dimensions shown. However, a 1" to 2" variance can still apply due to foam and upholstery.



## Bumper / Return Chaise & Conversation Sofas

Put Green Arrows with Red Arrows to Create Sectional Groups   
 Put Orange Arrows with Tan Arrows to Create Sectional Groups 

Bumper / Return Chaise  
not available for this style

Conversation Sofas  
not available for this style

## Sleepers

Put Green Arrows with Red Arrows to Create Sectional Groups   
 Put Blue Arrows with Yellow Arrows to Create Sectional Groups 

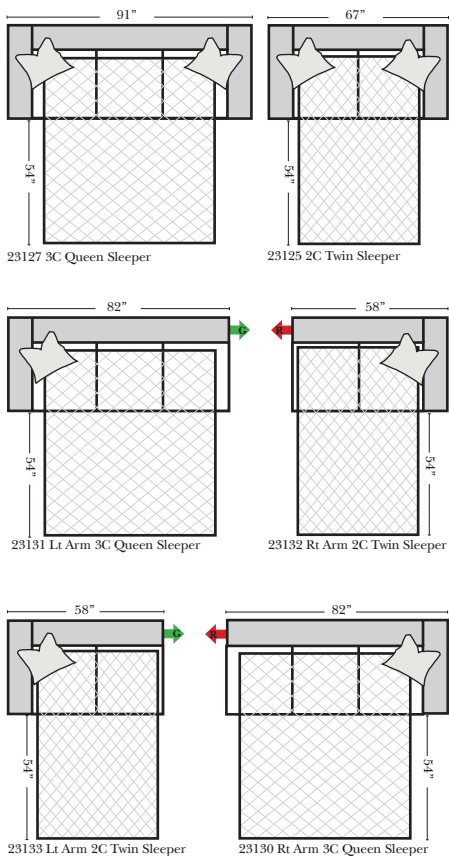

## Suggested Configurations

v.09.29.17

The Suggested Configurations below are only a sample of what the imagination can create, please enjoy creating the configuration that fits your lifestyle, using the ideas below and from the items on the opposite page.

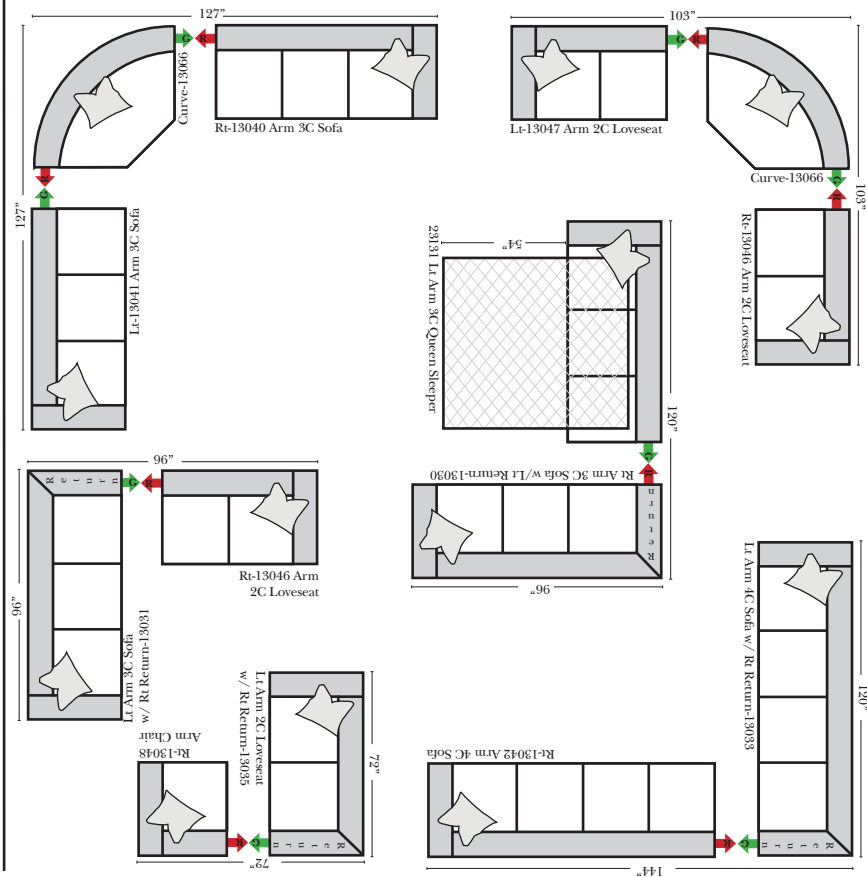

## Sleepers (Cont.)